

Article number: 01010311  
 Description: Retaining ring A 15 DIN 471  
 Stainless 411  
 Note: Fitted with ZGA pilers

## Measures

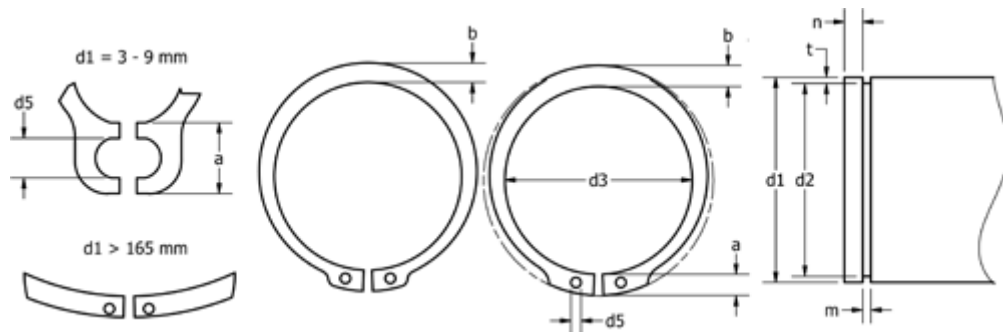

a max	= 3.6	FN kN	= 2.6	s	= 1.00
AN mm <sup>2</sup>	= 16.1	FRg kN	= 2.40	t	= 0.35
b	= 2.2	FR kN	= 6.90	tol	= -0.11
d1	= 15	g	= 1.0	tol	= -0.06
d2	= 14.3	K kN-mm	= 21.60	tol	= +0,10-0,36
d3	= 13.8	m min	= 1.10	Tong	= ZGA-1
d5 min	= 1.7	n abl x 1000	= 50.0	Weight kg/1000	= 0.670
Description	= A15	Nominal drive	= 1.1		